

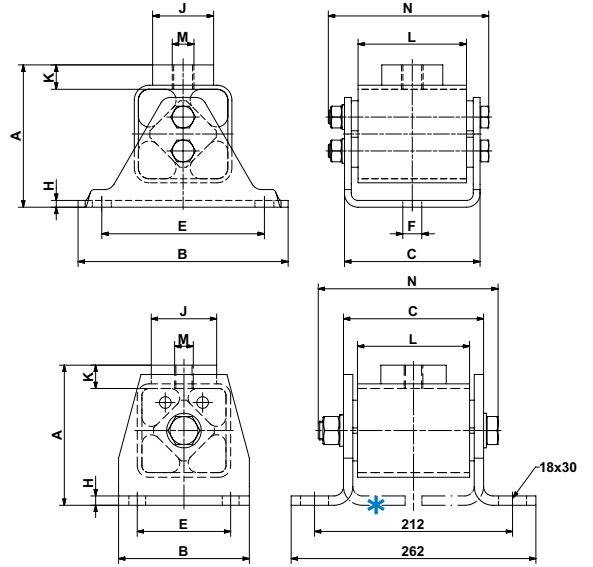

Anti-vibration Mounts

Type V

up to V 45



V 50

* Alternativ mounting position 180° turned.

Art. No.	Type	Load Gmin. – Gmax. [N] on X- and Z-axis	A	B	C	E	øF	H	øJ	K	L	M	N	Weight [kg]
05 011 001	V 15	300 – 800	49	80	51	55	9.5	3	20	10	40	M10	59	0.3
05 011 002	V 18	600 – 1'600	66	100	62	75	9.5	3.5	30	13	50	M10	74	0.7
05 011 003	V 27	1'300 – 3'000	84	130	73	100	11.5	4	40	14.5	60	M12	85	1.3
05 011 024	V 38	2'600 – 5'000	105	155	100	120	14	5	45	17.5	80	M16	117	2.7
05 011 005	V 45	4'500 – 8'000	127	190	122	140	18	6	60	22.5	100	M20	143	4.6
05 011 006	V 50	6'000 – 12'000	150	140	150	100	-	10	70	25	120	M20	193	7.5

Art. No.	Type	Natural frequency Gmin. – Gmax. [Hz]	Material structure (zinc-plated screws)
05 011 001	V 15	30 – 23	Light metal profiles, welded steel housings, ROSTA blue painted
05 011 002	V 18	25 – 15	
05 011 003	V 27	28 – 20	
05 011 024	V 38	14 – 12	
05 011 005	V 45	15 – 12	
05 011 006	V 50	12 – 10	

The max. load on **Y-axis** should not exceed **20%** of the X- resp. Z-axis capacity.

Momentary shock loads of 2.5 g in X- and Z-axis admissible.

Applicable on tensile, pressure and shear load.

Further information to customized elements and installation examples as from page 3.14.

Anti-vibration Mounts

Type V

Deflection curves

The mentioned deflection values are not suitable for type testing. Please consult also our tolerance data in the general catalogue, chapter "Technology".

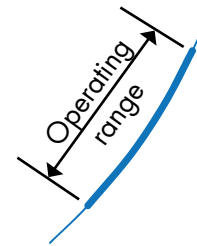
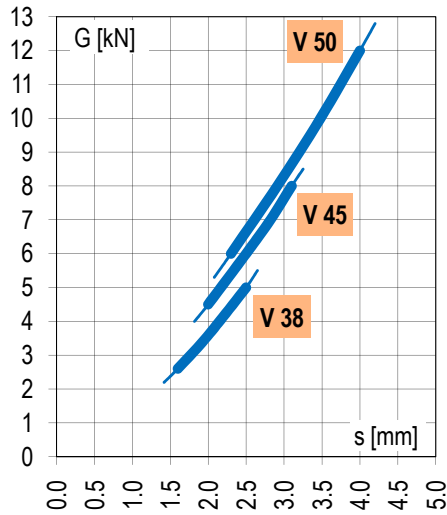
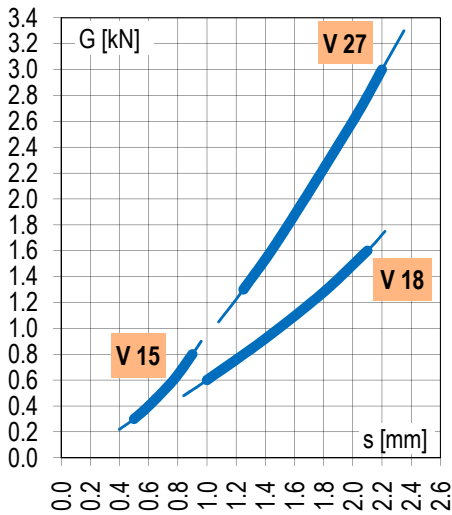

Installation guidelines

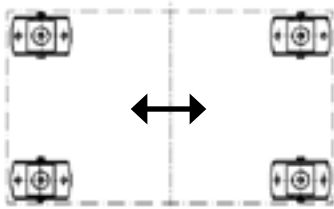

Dynamic forces longitudinal

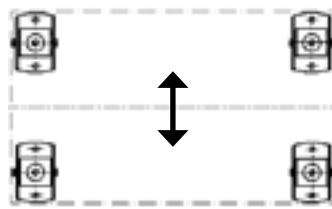

Dynamic forces lateral

45° diagonal configuration by rotary motions. Reduced load capacities.

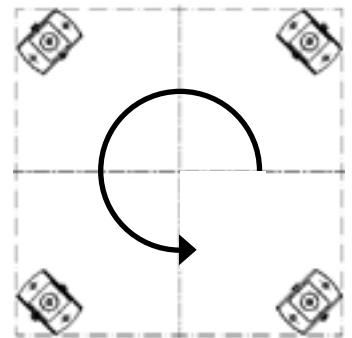





e. g. mixer, crusher installation

Applications

For active and passive isolation of vibrations and damping of solid-borne noise transmission in crushing plants, compressors, blowers, pumps, rotary converters, generators, mills, crane track supports, etc.

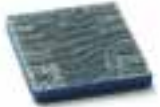
Selection table for Anti-vibration Mounts

Type	Description	Details	Illustration
ESL	<p>Anti-vibration Mounts for the absorption of tensile, pressure and shear load. Also ideal for wall and ceiling installations.</p> <p>8 load sizes from 200 N to 19'000 N per mount.</p> <p>Natural frequency between 3,5 – 8 Hz. Mounts are mainly used for overcritical machine installations (machine frequency > mount frequency).</p>	Page 3.8 – 3.9	
V	<p>Anti-vibration Mounts for the absorption of tensile, pressure and shear load. Also ideal for wall and ceiling installations.</p> <p>6 load sizes from 300 N to 12'000 N per mount.</p> <p>Natural frequency between 10 – 30 Hz. Mounts can be used for subcritical machine installations (machine frequency < mount frequency).</p>	Page 3.10 – 3.11	
N	<p>Mounting Feets consisting of insulating plate, glued-on top cover with built-in levelling jackscrew with spherical joint for compensation of up to 5° of floor unevenness. Insulating plate oil- and acid-proof.</p> <p>3 load sizes from 1'500 N to 20'000 N per mount.</p> <p>Natural frequency between 19 – 25 Hz.</p>	Page 3.12	
NOX	<p>Mounting Feets consisting of insulating plate, stainless steel glued-on top cover with built-in stainless levelling jackscrew with spherical joint for compensation of up to 5° of floor unevenness. Insulating plate oil- and acid-proof.</p> <p>2 load sizes from 5'000 N to 20'000 N per mount.</p> <p>Natural frequency between 19 – 22 Hz.</p>	Page 3.12	
Base plate P	<p>Accessories: For all N and NOX mounting feet light metal cast base plates are available for the compensation of possible shear loads and/or for the positioning of the installation on the floor.</p>	Page 3.12	
ISCOL	<p>Adhesive cushioning plates, self-adhesive plates for the installation of smaller machines/equipments. Plates oil- and acid-proof. (Adhesive power can be increased by moistening the plate with nitro thinner.)</p>	Page 3.13	
ISCOL U	<p>Adhesive cushioning plates, self-adhesive plates with glued-on cast cover. With central hollow in cover for the positioning of the levelling jackscrew – also with lateral stop bar for machine positioning.</p>	Page 3.13	

Further information to customized elements and installation examples as from page 3.14.